



**ELECTRO-OPTICS**

# **BRAVO**<sup>™</sup>

**BRAVO4<sup>™</sup> 4x30mm MEGAVIEW<sup>™</sup> BATTLE SIGHT**

**OWNERS MANUAL**

**SIG SAUER<sup>®</sup>**

## TABLE OF CONTENTS

Introduction . . . . .	3
Contents . . . . .	4
Key Features . . . . .	5
Product Identification . . . . .	6
Operation . . . . .	8
Mounting The Sight . . . . .	10
Sight Adjustments . . . . .	11
Maintenance . . . . .	13
Troubleshooting . . . . .	13
SIG SAUER® Electro-Optics Infinite Guarantee™ . . . . .	14
SIG SAUER Electronic & Tritium Component Limited 5-Year Warranty . . .	15
Specifications . . . . .	16

This manual is available in the following languages: French, Spanish, German, Italian, Portuguese, Russian, Afrikaans, Swedish, and Norwegian. Please visit [sigoptics.com](http://sigoptics.com) for Owners Manual downloads.

## INTRODUCTION

BRAVO4™ MegaView™ Battlesight. The BRAVO4 expands your vision with a massive 10° field of view, 42% wider than standard 7° sights. That's 53 feet of view at 100 yards vs. 37 feet, which could be the difference between seeing a threat, or not. This prism-powered battle sight also boasts unprecedented edge-to-edge clarity which means your target acquisition will be sure and fast. LensArmor™ abrasion-resistant coatings will withstand the harshest conditions.

The BRAVO4 is covered by SIG SAUER Electro-Optics Infinite Guarantee and SIG SAUER Electronic & Tritium Component Limited 5-Year Warranty.

**CONTENTS:**

- BRAVO4™ 4x30mm MegaView™ Battle Sight
- CR2 Battery
- Quick Release M1913 Picatinny Mount

## KEY FEATURES:

- MegaView™ system utilizes an advanced prism and ocular design yielding 42% greater field of view than the competitive prismatic battle sights
- MOTAC™ (Motion Activated Illumination) powers up when it senses motion and powers down when it does not. Provides for optimum operational safety and enhanced battery life
- The notably flat, distortion-free image boasts an unprecedented edge-to-edge clarity by means of a combination of Low Dispersion (LD) glass and aspherical lens design
- Lightweight yet durable magnesium housing with integrated Picatinny top rail for additional accessories such as MRDs and lasers
- Adjustable eyepiece with +/- 2 diopter correction
- Dependable IPX-8 waterproof (to 400 mbar or 13 ft) and fog-proof performance
- The BRAVO4 was engineered with the centerline of the optical axis at 1.535" above the top of an M1913 Picatinny rail interface for night vision compatibility
- SIG SAUER® Electro-Optics Infinite Guarantee™ and SIG SAUER Electronic & Tritium Component Limited 5-Year Warranty.

## PRODUCT IDENTIFICATION:

- A – Illumination Control and ON/OFF Button
- B – Battery Cap
- C – 1913 Picatinny Rail
- D – Windage Adjustment
- E – Elevation Adjustment
- F – QD Throw Lever
- G – Diopter Adjustment Ring
- H – Objective Lens
- I – Ocular Lens

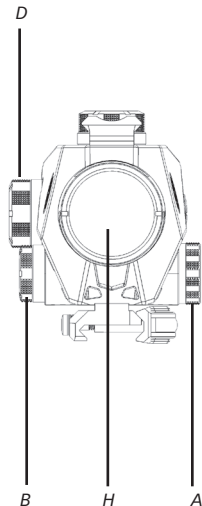

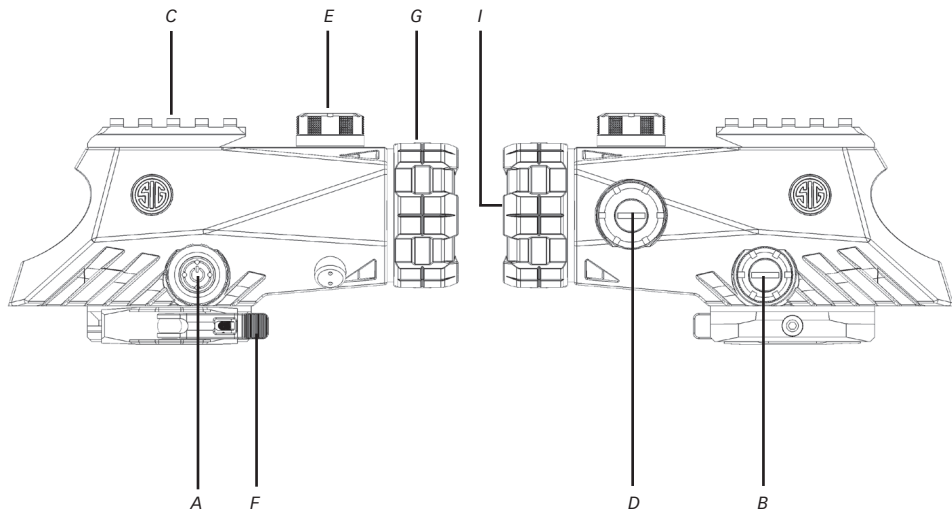

**⚠ WARNING**

Before working on your BRAVO4 sight always ensure that the firearm is unloaded with the safety on.

---

**OPERATION**

**Installing the battery**

The battery is mounted perpendicular to the viewing direction on the BRAVO4. To change the battery, remove the battery capped by rotating the cap in the counter-clockwise (CCS) direction. Remove the cap and insert a fresh CR2 battery positive (+) end first. The negative (-) should be facing outward. Replace the battery cap by rotating the cap clockwise (CW) until finger tight.

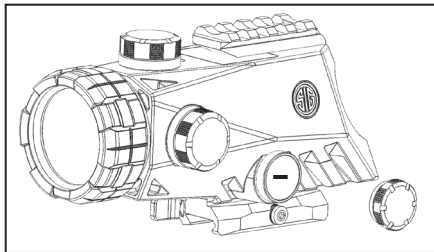



## Turning Sight On and Off

- The illumination control and ON/OFF button is located on the lower left hand side of the sight in the viewing direction.
- Turn the illumination on by pressing the ON/OFF button once.
- Turn the illumination off by pressing and holding the ON/OFF button for 1 second.
- The sight also features MOTAC™. It will automatically turn off after 6 minutes of non use. As soon as the sight senses motion it will automatically power back on to the current setting.
- The sight has 20 illumination settings, 15 daytime and 5 NV.

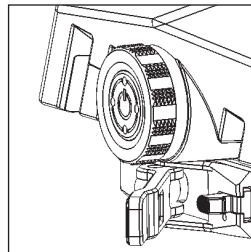

## MOUNTING THE SIGHT

- The QD mount that comes with your BRAVO4 sight is nominally set to 1.535 inches to the optical axis, which is ideal for use with NV and thermal clip-on sights.
- The QD mount is attached to a MIL-STD 1913 Picatinny Rail by setting it on your rail and rotating the QD lever backwards or counter-clockwise when looking down on the sight.
- The BRAVO4 was designed for use on most types of firearms that utilize the MIL-STD 1913 Picatinny Rail.
- Mount the firearm to your shoulder and then set the sight at the proper eye relief. Eye relief is set properly when the sight image fills the entire field of view of the ocular lens.

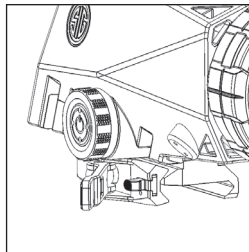

## SIGHT ADJUSTMENTS

- Windage and elevation adjustments are located on the rear top and rear right side of the sight. Windage and Elevation sight adjustments can be made once the caps are removed.
- Elevation adjustments - the elevation adjustment is on the top of your sight. To raise your point of impact turn the adjustment counter-clockwise. Each click is equal to 0.5 MOA. To lower the point of impact turn the adjustment clockwise.
- Windage adjustments - the windage adjustment is on the right side of your sight. To shift your point of impact to the right turn the adjustment counter-clockwise. Each click is equal to 0.5 MOA. To shift the point of impact to the left turn the adjustment clockwise.
- Windage and Elevation sight adjustments can be made once the caps are removed.

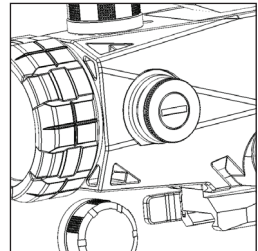
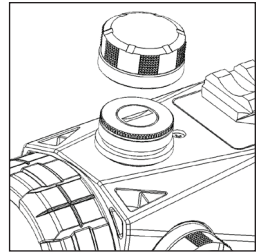

## DIOPTER ADJUSTMENT

- Aim the sight at a light object to maximize the contrast of the reticle. Turn the diopter until the reticle comes into focus.

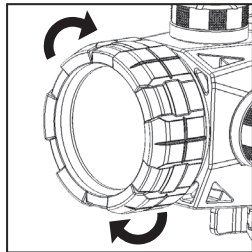

## MAINTENANCE

- Cleaning – Keep your lenses clear by using a soft cloth or lens pen. The best way to maintain image quality is by keeping your lenses clear of dirt and dust that cause scratches.
- Always use your sight cover to ensure that the sight optics remain scratch free.

## TROUBLESHOOTING

POI changes between groups

- Check that the QD mount is affixed tightly to the rail.
- Check/Clean your firearm.
- Check for variations in ammunition.



### **SIG SAUER Electro-Optics Infinite Guarantee™**

SIG SAUER has manufactured the most rugged, dependable high-performance firearms for over two centuries. Our heritage of design, engineering and precision-manufactured quality predates the existence of any other optics company worldwide. We understand the importance of quality in the line of fire, at the shooting range or on your next hunt. SIG SAUER Electro-Optics had to earn the right to wear that badge and the Infinite Guarantee has your back, forever. Period.

We will repair or replace your SIG SAUER product in the event it becomes damaged or defective, at no charge to you. If we cannot repair your product, we will replace it with a product in perfect working order of equal or better physical condition. It doesn't matter how it happened, whose fault it was, or where you purchased it.

### **SIG SAUER Infinite Guarantee™**

- Unlimited Lifetime Guarantee
- Fully Transferable
- No Warranty Card Required
- No Receipt Required
- No Time Limit Applies
- No Charge

If you ever have a problem, no matter the cause, we promise to take care of you when it counts. Please note that our Infinite Guarantee does not provide coverage for intentional damage, misuse, cosmetic damage that does not affect the performance of the optic, loss, theft or unauthorized repair or modification. Excludes electronic components.



### **SIG SAUER Electronic & Tritium Component Limited 5-Year Warranty**

For components not included under the SIG SAUER® Infinite Guarantee™, this warranty covers any defects in materials and workmanship in the electronic and Tritium components of illuminated riflescopes/sights, pistol sights, electronic sights, flashlights, lasers, binoculars, spotting scopes, and rangefinders. This warranty lasts for five years from the date of manufacture. If, during that five-year period, these products are found to have electronic or Tritium component defects in materials or workmanship, SIG SAUER will repair your product, at no charge to you. If we cannot repair your product, we will replace it with a product in perfect working order of equal or better physical condition.



**BRAVO4 SPECIFICATIONS**

<b>Magnification</b>	4x
<b>Clear Aperture</b>	30mm
<b>Illumination Settings</b>	15 Day / 5 NV
<b>Sight Height to Optical Axis</b>	1.535 in
<b>Elevation Adjustment Range</b>	+/- 30 MOA
<b>Windage Adjustment Range</b>	+/- 30 MOA
<b>Diopter</b>	+/- 2.0
<b>Exit Pupil</b>	7.5mm
<b>Angular FOV</b>	10 degrees
<b>Eye Relief</b>	2.2 inches / 55mm
<b>FOV</b>	53 ft @ 100 yards / 17.5 mm @ 100m
<b>Weight</b>	19.3 oz / 546 g
<b>Battery</b>	CR2
<b>Waterproofing</b>	IPX-8



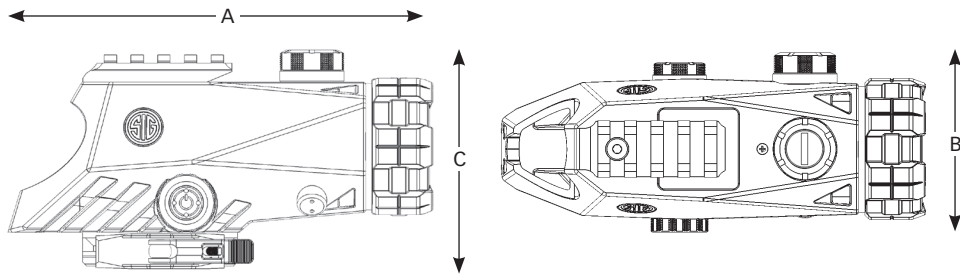

A – 6.3 in / 159mm  
B – 2.6 in / 67mm  
C – 3.2 in / 82mm

**NOTES:**





**FOR PRODUCT SERVICE ON THIS MODEL, PLEASE CALL 603-610-3000**

19861 SW 95th Avenue, Portland, OR 97062 USA