

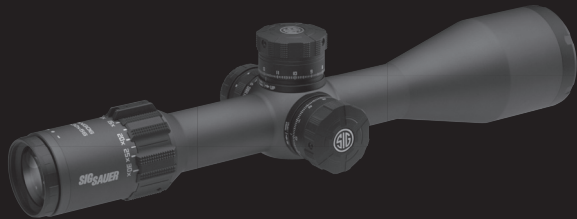

ELECTRO-OPTICS



TANGO™

TANGO6™ TACTICAL RIFLESCOPES

OWNERS MANUAL

SIG SAUER®

TABLE OF CONTENTS

Introduction	3
Contents	4
Features	5
Product Identification	6
Operation	8
Illumination Brightness level.	10
Sight Adjustments.	14
Maintenance	22
Troubleshooting	23
Specifications	24
SIG SAUER® Electro-Optics Infinite Guarantee™	30
SIG SAUER Electronic Component Limited 5-Year Warranty	31

This manual is available in the following languages: French, Spanish, German, Italian, Portuguese, Russian, Afrikaans, Swedish, and Norwegian. Please visit sigsauer.com for Owners Manual downloads.

INTRODUCTION

No one understands the need for unquestioning accuracy better than SIG SAUER®. Our tactical riflescopes have been developed for military, law enforcement, long range hunters, and competitive shooters for one reason: When you take your shot, it will count.

TANGO6™ models are designed for the most demanding shooters. These variable power 6:1 HDX optics offer a clear image over the entire range of magnification. They also feature our HellFire illuminated reticle system, an advanced electronic motion sensing illumination system and pop-up lockable turrets with zero stop adjustments for an easy return to zero.

CONTENTS:

- TANGO6 Riflescope
- CR2032 Battery
- Riflescope cover
- Tools
- Sunshade (select models)
- Throw Lever (select models)
- Manual

FEATURES

- Offered in First and Second Focal Plane with multiple illuminated reticle options
- HellFire™ electronic-illuminated reticle system using advanced fiber-optic technology to vary the light intensity of the central aiming point in any light condition.
- HDX™ optics- extra low dispersion glass (HD) combined with high transmittance glass (HT) provide industry leading light transmission and optical clarity for any situation.
- LevelPlex™ Digital Anti-Cant System
- MOTAC™ (Motion Activated Illumination System) that powers up when it senses motion and powers down when it does not. Provides for optimum operational safety and enhanced battery life.
- Dependable waterproof (IPX-7 rated for complete immersion up to 1 meter) and fog proof performance.
- LockDown™ Zero System technology featuring turrets that pop-up and lock in place.

TANGO6 Riflescopes are equipped with rugged tactical turrets. TANGO6 turrets feature:

- LockDown™ Zero System
- Lock at any position
- Inifinitely adjustable zero stop
- 120 Clicks per rotation
- Rotation indicator

PRODUCT IDENTIFICATION

- A Objective Lens
- B Main Tube
- C Illumination Power Selector Ring/ Parallax Adjustment Ring (select models)
- D Elevation Dial
- E Windage Dial
- F Power Selector Ring
- G Diopter Adjustment Ring
- H Ocular Lens

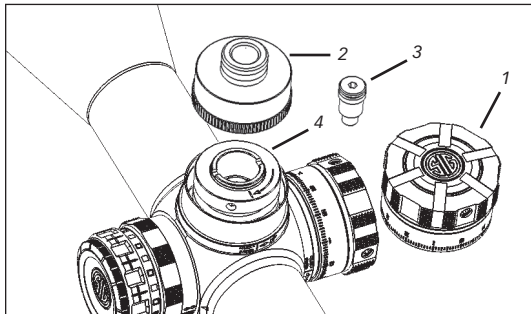

Elevation Turret

- 1 Elevation Dial
- 2 Adjustment Shroud
- 3 Adjustment Shroud Hex Screw
- 4 Zero Stop Outer Rim

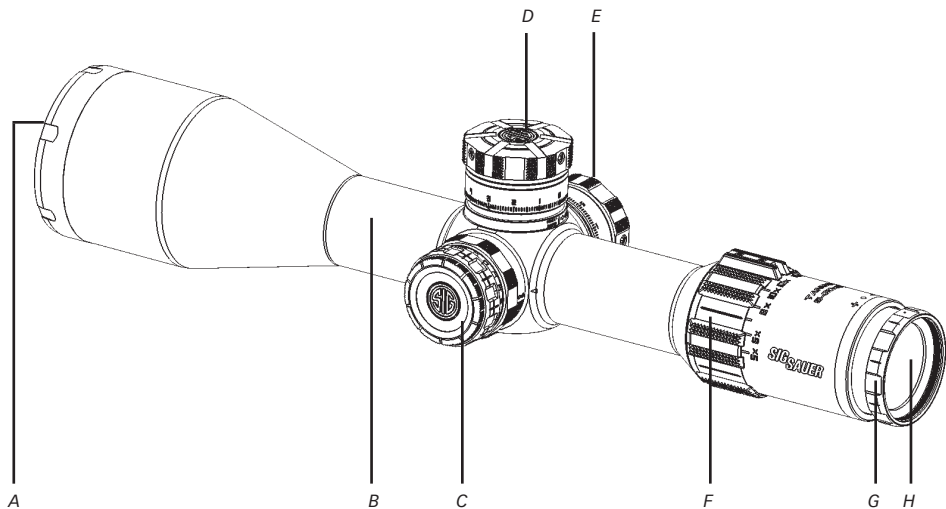

WARNING

Before working on your TANGO6 riflescope always ensure that the firearm is unloaded with the safety on.

OPERATION

Installing the battery

TANGO6 riflescopes are equipped with illuminated reticles and require CR2032 batteries. To install the battery loosen the battery port cover on the left side of the riflescope turret. Place the battery into the battery port with the plus side facing outward. Screw the battery port cover back onto the left side of the turret.

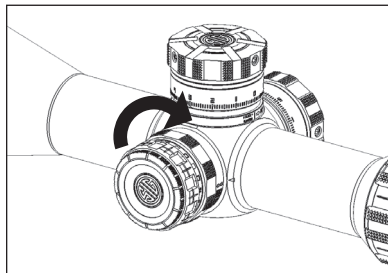
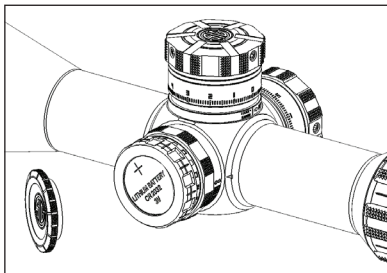
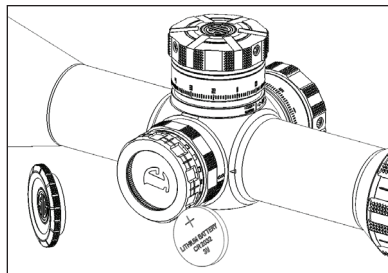
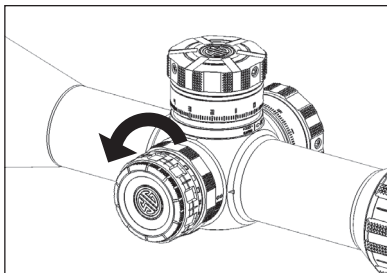

ILLUMINATION BRIGHTNESS LEVEL

- Select the illumination brightness level that suits your conditions the best
- Higher power settings, indicated by larger squares, are better suited for brighter conditions
- Lower power settings, indicated by smaller squares, are better suited for low light conditions
- Brightness level settings alternate between on and off locations. Filled in squares indicate on positions.
- TANGO6 riflescopes feature MOTAC, they will automatically turn off after 6 minutes of rest. They will automatically power on after first motion.
- LevelPlex models only have one off position. The brightness of the LevelPlex indicator correlates to the reticle brightness selected.

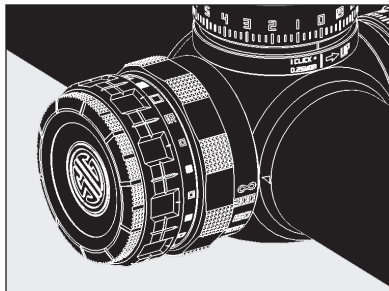

LEVELPLEX

- LevelPlex is a digital anti-cant system. It is used to ensure that your scopes is perfectly level. It is designed to greatly increase long range accuracy. LevelPlex can also be used as an aid in leveling your scope when installing it on your firearm.
- Users can select from 3 different brightness levels and 2 leveling coarseness settings for LevelPlex when they chose to use the system without their reticle illuminated.
- To reach the setting menu select the off position for the reticle illumination and hold the LevelPlex button in for 3 seconds. This beings a round robin menu that will toggle through 3 brightness settings for +/- 0.5° on the left side indicator and 3 brightness settings for +/- 1.0° on the right side indicator (left side will be flashing and the right side will be solid). When you find the setting you desire release the LevelPlex button.
- Once you chose between the fine and coarse LevelPlex setting it will be consistent throughout all reticle illumination settings.

MODE	TILT THRESHOLD	TILT BRIGHTNESS (also shown on indicator LED)	INDICATION DURING ROUND-ROBIN
"Fine"	0.5 degree	low	'LEFT' LED, 3 blinks per second
		med	
		high	
"Coarse"	1.0 degree	low	'RIGHT' LED, solid 'on'
		med	
		high	

Mounting the riflescope

Choose rings and bases that correspond to your firearms action and the diameter of your riflescope's maintube. In order to maintain a comfortable cheek weld always mount your riflescope with the lowest possible ring height. Make sure that there is no interference with any of the moving parts of your firearm.

LevelPlex can be utilized as a mounting aid. Make sure that your firearm is level and activate LevelPlex. When the indicators show that the scope is level tighten your rings to the appropriate torque.

Set proper eye relief

Slightly loosen the riflescope rings and position the riflescope as far forward as it will mount. For adjustable power riflescopes select the highest possible power. Mount the rifle in a comfortable and repeatable, natural position. Adjust the position of the riflescope backwards until you have maximum field of view in your riflescope.

Ensure that the vertical crosshair of the riflescope matches the vertical centerline of your rifle and tighten the rings and bases to the correct torque

- To turn the illuminated reticle on rotate the illumination power selector ring to the desired level.
- To turn the illuminated reticle off rotate the illumination power selector ring to an empty square.

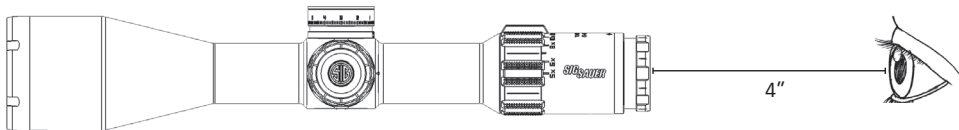

SIGHT ADJUSTMENTS

The riflescope will come centered. This will get you close to your rifles zero out of the box.

Focusing the reticle with the diopter

Aim the riflescope at a light object to maximize the contrast of the reticle. Turn the diopter until the reticle comes into focus.

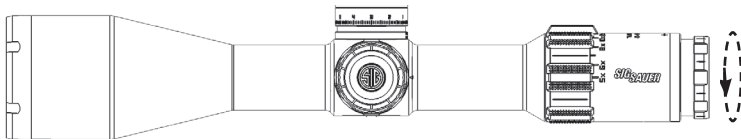

Adjusting Power

TANGO6 riflescopes are variable power. In order to increase the power setting rotate the power selector ring clockwise. Turn the power selector ring until the image is magnified to the desired range.

Bore sighting

If you are installing the riflescope from other than its factory settings it is best to bore site your riflescope. This will give you a coarse zero and will require further adjustments.

With the rifle in a firm rest, remove the bolt from your rifles action (with AR style rifles remove the rifles upper from its lower assembly and remove the bolt carrier). Look through the rifles barrel from the rear of the rifle and aim it so that your target is centered. Without moving the position of the barrel, use the elevation and windage adjustments of your riflescopes reticle so that it is also in the center of the target.

Parallax Adjustment*

When using your riflescope for longer range targets, parallax can become more noticeable. This can be noticed when it appears that your reticle is moving separate from the target when you move your head/eye from side to side. To adjust parallax rotate the parallax dial clockwise for increased distances. Turn the dial until the parallax is corrected.

*Certain models offer adjustment on the left side of the turret.

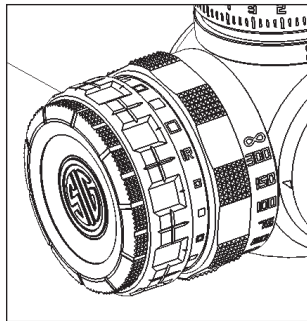

Point of Impact (POI) corrections

POI corrections should be done using the center of a three shot group. If you are not able to get a consistent three shot group then you will need to further trouble shoot your firearm.

If your POI is located to the left of your point of aim (POA), you will need to adjust the windage to the right. To adjust the windage to the right you must release the lock of the windage adjustment dial by pulling it outwards. Once the dial is pulled out you are able to make POI adjustments. To move the POI to the right turn the windage adjustment dial counter-clockwise. To move the POI to the left turn the windage adjustment dial clockwise. Once you are satisfied with your POI, lock the dial but pressing it in.

If your POI is located below your POA you will need to adjust the elevation adjustment dial up. To adjust the elevation up you must release the lock of the elevation adjustment dial by pulling it up. Once the lock is released you are able to make POI adjustments. To move the POI up you will need to turn the elevation adjustment dial counter-clockwise. To move the POI down you will need to turn the elevation adjustment dial clockwise.

Once your POI is located where you want it in relation to your POA you can lock your adjustment dials, reset your zero, and set your zero lock.

Setting the Zero Stop

To set your zero stop you will need to remove the elevation adjustment dial from your rifle scope. This is done by loosening the top three hex screws located in the knurling of your dial using the provided 2mm hex wrench. Once these are removed the dial can be removed by lifting it straight up.

Once you have removed your elevation adjustment dial the adjustment shroud should be visible. This will also need to be removed to set your zero stop. To remove the adjustment shroud loosen the hex screw in the middle of the shroud using the provided 2mm hex wrench until it spins freely. Pull up on the shroud and remove it entirely.

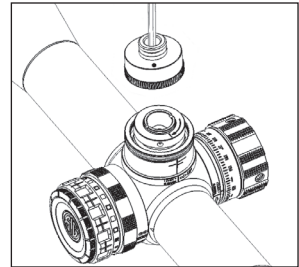
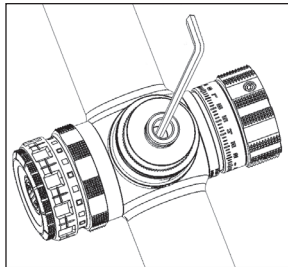
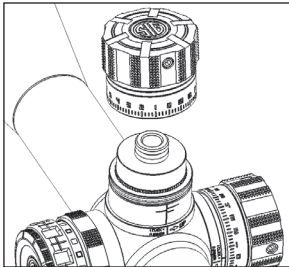
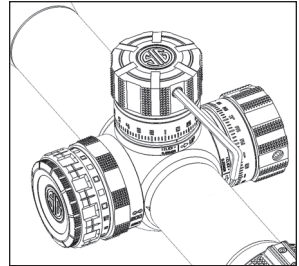

The zero stop mechanism should now be visible. To set the zero stop, loosen the three set screws on the mechanism's outer rim using the provided 1.5mm hex wrench. Once the outer rim is loose and can rotate freely, gently spin it clockwise until it stops. Re-tighten the set screws to finger tight or 25 in-oz (1.56 in-lbs / 0.177 N-m) of torque.

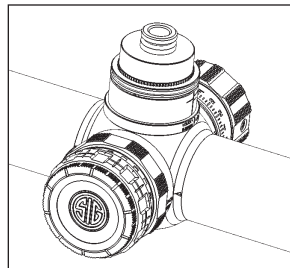
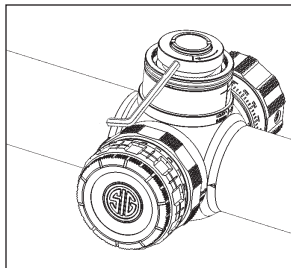
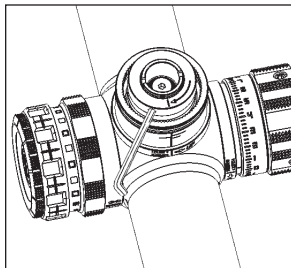

You will now need to place the adjustment shroud back on the scope. This can be done by orientating it in the same manner that it was previously and tightening the center hex screw to finger tight or 8 in-lbs (0.9 N-m) of torque.

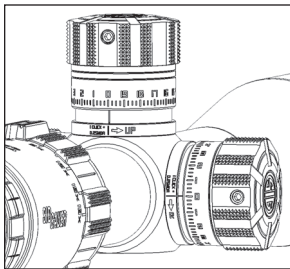
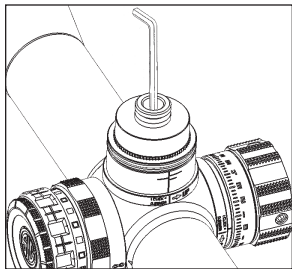

Once the adjustment shroud is reassembled, you can place the adjustment dial back in its original position (at the zero position in most cases).

Resetting the Zero of your adjustment dials

Both the elevation and windage adjustment dials of TANGO6 riflescopes are able to be zeroed. This is done by loosening the three set screws on each dial using the provided 2mm hex wrench and rotating it until it is zeroed. Be sure to loosen the set screws enough so that the dial spins freely. Once the dial is zeroed, tighten the set screws to finger tight or 8 in-lbs (0.9 N-m).

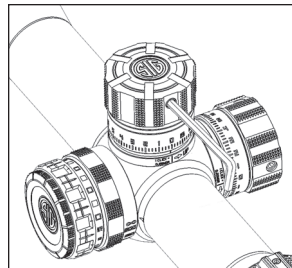

TANGO6 riflescopes feature a rotation indicator. The indicator is meant to be used with the adjustment dial in the up position.

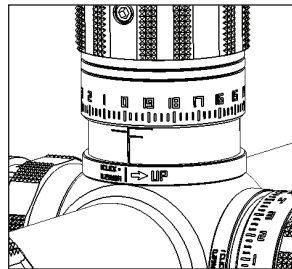

Installing a SBT™ SIG Ballistic Turret Dial

- Remove the elevation adjustment dial by loosening the three set screws near the knurling of the dial. Once these are loose the dial should pull free of the adjustment shroud.
- Place the new SBT dial on the adjustment shroud and reset your zero.
- Tighten your set screws to finger tight or 8 in-lbs (0.9 N-m).

MAINTENANCE

Your SIG SAUER riflescope requires very low maintenance.

- If your riflescope came with an illuminated reticle make sure that you turn the illumination control to one of the off positions when it is not in use.
- If the battery for your illuminated reticle is dead replace it by rotating the illumination battery port cap counter-clockwise. Replace the battery with a new CR2032 battery positive side facing out.
- Keep your lenses clear by using a soft cloth or lens pen. The best way to maintain image quality is by keeping your lenses clear of dirt and dust that cause scratches.

TROUBLESHOOTING

POI changes between groups

- Check that all of your mounts are tightened to the correct torque specification
- Check/Clean your rifle
- Check for variations in ammunition

Illuminated reticle does not work

- Check that the battery is installed correctly
- Replace battery
- Ensure that the illumination power selector ring is in an on position

TANG06 SPECIFICATIONS

Model	Focal Place	Reticle	ADJ.	Exit Pupil MM		Linear Field of View				Eye Relief			
				LOW	HIGH	FT @ 100Yds		M @ 100M		INCH		MM	
						LOW	HIGH	LOW	HIGH	LOW	HIGH	LOW	HIGH
1 - 6x24mm	1st	5.56/7.62 Horseshoe Dot	.5 MOA	12	4	92	17	30.6	5.7	3.8 SFP	3.9 SFP	97.5 SFP	98.5 SFP
		300 Blackout Horseshoe Dot											
	2nd	Hellfire Triplex	.2 MRAD							4.25 FFP	3.8 FFP	108 FFP	96 FFP
		Hellfire MOA Milling											
Hellfire MRAD Milling													
		Hellfire 3 Gun											
3 - 18x44mm	1st	MOA Milling Illuminated	.25 MOA	12	2.4	32	5.8	10.7	1.9	3.74	3.7	95	94
		MRAD Milling Illuminated	.1 MRAD										
		MOA DEV-L Milling Illuminated	.25 MOA										
		MRAD DEV-L Milling Illuminated	.1 MRAD										

Model	Objective Filter Thread	Objective Clear Aperture		Weight		Elevation Adjustment Range	Windage Adjustment Range	Illumination Settings	Length	
		INCH	MM	OUNCE	GRAM				INCH	MM
1 - 6x24mm	M 25.5 x 0.6	0.9	24	20.97	594	125 MOA 36.3 MRAD	125 MOA 36.3 MRAD	9 daytime / 2 NV	10.25	260
3 - 18x44mm	M 46 X 0.75	1.7	44	37.57	1065	95 MOA 27.6 MRAD	95 MOA 27.6 MRAD	7 daytime / 2 NV	12.38	315

TANG06 SPECIFICATIONS

Model	Focal Place	Reticle	ADJ.	Exit Pupil MM		Linear Field of View				Eye Relief			
				LOW	HIGH	FT @ 100Yds		M @ 100M		INCH		MM	
						LOW	HIGH	LOW	HIGH	LOW	HIGH	LOW	HIGH
4 - 24x50mm	1st	MOA Milling Illuminated	.25 MOA	11.6	2.1	24.7	4.6	8.2	1.5	3.4	3.7	86	93
		MRAD Milling Illuminated	.1 MRAD										
		MOA DEV-L Milling Illuminated	.25 MOA										
		MRAD DEV-L Milling Illuminated	.1 MRAD										
5 - 30x56mm	1st	MOA Milling Illuminated	.25 MOA	8.9	1.9	18.9	3.3	6.3	1.1	3.6	3.5	92	89
		MRAD Milling Illuminated	.1 MRAD										
		MOA DEV-L Milling Illuminated	.25 MOA										
		MRAD DEV-L Milling Illuminated	.1 MRAD										

Model	Objective Filter Thread	Objective Clear Aperture		Weight		Elevation Adjustment Range	Windage Adjustment Range	Illumination Settings	Length	
		INCH	MM	OUNCE	GRAM				INCH	MM
4 - 24x50mm	M 52 x 0.75	1.97	50	39.34	1115.8	80 MOA 23.2 MRAD	80 MOA 23.2 MRAD	7 daytime / 2 NV	13.6	344
5 - 30x56mm	M 56 0.75	2.2	56	42	1191	80 MOA 23.2 MRAD	50 MOA 14.5 MRAD	7 daytime / 2 NV	14.38	365

Reticle Options

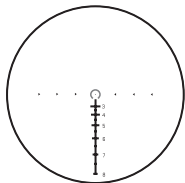

*5.56/7.62
Horseshoe Dot*

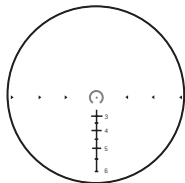

*.300 Blackout
Horseshoe Dot*

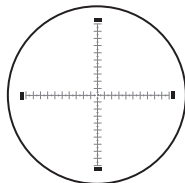

MOA Milling

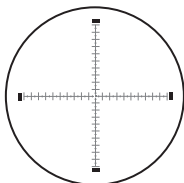

MRAD Milling

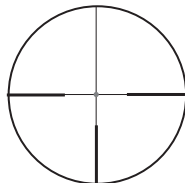

HellFire™ Triplex

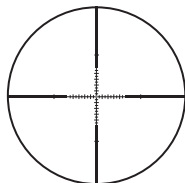

3 Gun

Go to sigsauer.com for detailed information on reticle subtensions.

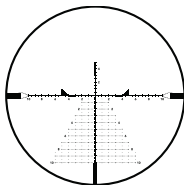

*MRAD
Hellfire Milling*

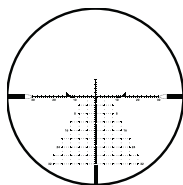

*MOA
Hellfire Milling*

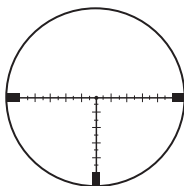

*MRAD
Milling SFP*

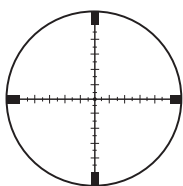

*MOA
Milling SFP*

If you ever have a problem, no matter the cause, we promise to take care of you when it counts. Please note that our Infinite Guarantee does not provide coverage for intentional damage, misuse, cosmetic damage that does not affect the performance of the optic, loss, theft or unauthorized repair or modification. Excludes electronic components.



SIG SAUER Electronic Component Limited 5-Year Warranty

For components not included under the SIG SAUER Infinite Guarantee, this warranty covers any defects in materials and workmanship in the electronic components of illuminated riflescopes/sights, electronic sights, flashlights, lasers, binoculars, spotting riflescopes and rangefinders. This warranty lasts for five years from the date of manufacture. If, during that five-year period, these products are found to have electronic component defects in materials or workmanship, SIG SAUER will repair your product, at no charge to you. If we cannot repair your product, we will replace it with a product in perfect working order of equal or better physical condition. This warranty gives you specific legal rights, and you may also have other rights which vary from state to state.





SIG SAUER Electro-Optics Infinite Guarantee™

SIG SAUER has manufactured the most rugged, dependable high-performance firearms for over two centuries. Our heritage of design, engineering and precision-manufactured quality predates the existence of any other optics company worldwide. We understand the importance of quality in the line of fire, at the shooting range or on your next hunt. SIG SAUER Electro-Optics had to earn the right to wear that badge and the Infinite Guarantee has your back, forever. Period.

We will repair or replace your SIG SAUER product in the event it becomes damaged or defective, at no charge to you. If we cannot repair your product, we will replace it with a product in perfect working order of equal or better physical condition. It doesn't matter how it happened, whose fault it was, or where you purchased it.

SIG SAUER Infinite Guarantee™

- Unlimited Lifetime Guarantee
- Fully Transferable
- No Warranty Card Required
- No Receipt Required
- No Time Limit Applies
- No Charge



FOR PRODUCT SERVICE ON THIS MODEL, PLEASE CALL 603-610-3000

19861 SW 95th Avenue, Portland, OR 97062 USA