

# INSTRUCTION MANUAL FOR

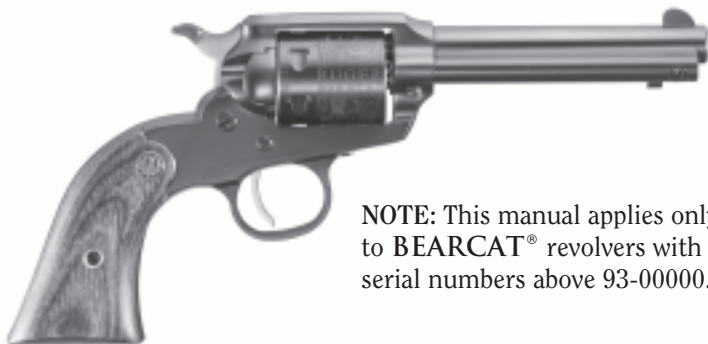

## RUGER® NEW BEARCAT® SINGLE-ACTION REVOLVERS



NOTE: This manual applies only to BEARCAT® revolvers with serial numbers above 93-00000.

– RUGGED, RELIABLE FIREARMS® –



**READ THE INSTRUCTIONS AND  
WARNINGS IN THIS MANUAL CAREFULLY  
BEFORE USING THIS FIREARM**

© 2016 Sturm, Ruger & Co., Inc.

This manual may not be reproduced in whole or in part without the express written permission of Sturm, Ruger & Co., Inc.

**For Service on This Model Please Call:  
(336) 949-5200 (See p. 24)**

THIS INSTRUCTION MANUAL SHOULD ALWAYS ACCOMPANY THIS FIREARM AND BE TRANSFERRED WITH IT UPON CHANGE OF OWNERSHIP, OR WHEN THE FIREARM IS LOANED OR PRESENTED TO ANOTHER PERSON.

[WWW.RUGER.COM](http://WWW.RUGER.COM)

## State-By-State Warnings

Certain states require by law that their own specified warning notices in larger-than-normal type be conspicuously included by the manufacturer, distributor or retailer with firearms sold in that state. Sturm, Ruger & Co., Inc. sells its products in compliance with applicable laws and regulations. Because our products may be sold in these states, we include the following:

### California:

#### **WARNING**

“Children are attracted to and can operate firearms that can cause severe injuries or death. Prevent child access by always keeping guns locked away and unloaded when not in use. If you keep a loaded firearm where a child obtains and improperly uses it, you may be fined or sent to prison.”

#### **ADVERTENCIA**

“A los niños los atraen las armas de fuego y las pueden hacer funcionar. Ellos pueden causarse lesiones graves y la muerte. Evite que los niños tengan acceso a las armas de fuego guardándolas siempre con llave y descargadas cuando no las esté utilizando. Si usted tiene un arma de fuego cargada en un lugar en que un niño tiene acceso a ella y la usa indebidamente, le pueden dar una multa o enviarlo a la cárcel.”

### Connecticut:

“UNLAWFUL STORAGE OF A LOADED FIREARM MAY RESULT IN IMPRISONMENT OR FINE.”

### Florida:

“IT IS UNLAWFUL, AND PUNISHABLE BY IMPRISONMENT AND FINE, FOR ANY ADULT TO STORE OR LEAVE A FIREARM IN ANY PLACE WITHIN THE REACH OR EASY ACCESS OF A MINOR UNDER 18 YEARS OF AGE OR TO KNOWINGLY SELL OR OTHERWISE TRANSFER OWNERSHIP OR POSSESSION OF A FIREARM TO A MINOR OR A PERSON OF UNSOUND MIND.”

## **Maine:**

“ENDANGERING THE WELFARE OF A CHILD IS A CRIME. IF YOU LEAVE A FIREARM AND AMMUNITION WITHIN EASY ACCESS OF A CHILD, YOU MAY BE SUBJECT TO FINE, IMPRISONMENT OR BOTH. KEEP FIREARMS AND AMMUNITION SEPARATE. KEEP FIREARMS AND AMMUNITION LOCKED UP. USE TRIGGER LOCKS.”

## **Maryland:**

“WARNING: Children can operate firearms which may cause death or serious injury. It is a crime to store or leave a loaded firearm in any location where an individual knew or should have known that an unsupervised minor would gain access to the firearm. Store your firearm responsibly!”

## **Massachusetts:**

“WARNING FROM THE MASSACHUSETTS ATTORNEY GENERAL: This handgun is not equipped with a device that fully blocks use by unauthorized users. More than 200,000 firearms like this one are stolen from their owners every year in the United States. In addition, there are more than a thousand suicides each year by younger children and teenagers who get access to firearms. Hundreds more die from accidental discharge. It is likely that many more children sustain serious wounds, or inflict such wounds accidentally on others. In order to limit the chance of such misuse, it is imperative that you keep this weapon locked in a secure place and take other steps necessary to limit the possibility of theft or accident. Failure to take reasonable preventive steps may result in innocent lives being lost, and in some circumstances may result in your liability for these deaths.”

“IT IS UNLAWFUL TO STORE OR KEEP A FIREARM, RIFLE, SHOTGUN OR MACHINE GUN IN ANY PLACE UNLESS THAT WEAPON IS EQUIPPED WITH A TAMPER-RESISTANT SAFETY DEVICE OR IS STORED OR KEPT IN A SECURELY LOCKED CONTAINER.”

**New Jersey:**

“IT IS A CRIMINAL OFFENSE TO LEAVE A LOADED FIREARM WITHIN EASY ACCESS OF A MINOR.”

**New York City:**

“THE USE OF A LOCKING DEVICE OR SAFETY LOCK IS ONLY ONE ASPECT OF RESPONSIBLE FIREARM STORAGE. FOR INCREASED SAFETY, FIREARMS SHOULD BE STORED UNLOADED AND LOCKED IN A LOCATION THAT IS BOTH SEPARATE FROM THEIR AMMUNITION AND INACCESSIBLE TO CHILDREN AND OTHER UNAUTHORIZED PERSONS.”

**North Carolina:**

“IT IS UNLAWFUL TO STORE OR LEAVE A FIREARM THAT CAN BE DISCHARGED IN A MANNER THAT A REASONABLE PERSON SHOULD KNOW IS ACCESSIBLE TO A MINOR.”

**Texas:**

“IT IS UNLAWFUL TO STORE, TRANSPORT, OR ABANDON AN UNSECURED FIREARM IN A PLACE WHERE CHILDREN ARE LIKELY TO BE AND CAN OBTAIN ACCESS TO THE FIREARM.”

**Wisconsin:**

“IF YOU LEAVE A LOADED FIREARM WITHIN THE REACH OR EASY ACCESS OF A CHILD YOU MAY BE FINED OR IMPRISONED OR BOTH IF THE CHILD IMPROPERLY DISCHARGES, POSSESSES, OR EXHIBITS THE FIREARM.”

\* \* \* \* \*

Please check with your licensed retailer or state police for additional warnings which may be required by local law or regulation. Such regulations change constantly, and local authorities are in the best position to advise you on such legal matters.

**FIREARMS SAFETY IS YOUR RESPONSIBILITY**  
**SAFETY MUST BE THE FIRST AND CONSTANT**  
**CONSIDERATION OF EVERY PERSON WHO HANDLES**  
**FIREARMS AND AMMUNITION.**

This Instruction Manual is designed to assist you in learning how to use and care for your RUGER® NEW BEARCAT® revolver properly. Please contact us if you have any questions.

Only when you are certain you fully understand the manual and can properly carry out its instructions should you practice loading, unloading, etc. with live ammunition. If you have any doubts about your ability to handle or use a particular type of gun safely, you should seek supervised instruction. Such personalized instruction often is available from local gun retailers, gun clubs or police departments. If none of these sources can help, visit [www.nra.org](http://www.nra.org) or write to the following address:

National Rifle Association  
11250 Waples Mill Road  
Fairfax, VA 22030-7400

The person possessing a gun has a full-time job. You cannot guess; you cannot forget. You must know how to use your firearm safely. **Do not use any firearm without having a complete understanding of its particular characteristics and safe use.** Remember: There is no such thing as a foolproof gun.

# TABLE OF CONTENTS

	Page
State-By-State Warnings .....	2
Nomenclature .....	7
Locking Device Installation Instructions .....	8
General Information and Mechanical Characteristics .....	10
New Bearcat® Mechanism .....	11
Ammunition .....	12
To Load and Fire .....	13
To Uncock (Decock) The Revolver .....	13
To Unload or Eject Cartridge Cases .....	16
To Remove or Replace Cylinder .....	17
Disassembly .....	18
To Disassemble for Cleaning .....	18
To Dismantle Interior Parts .....	19
Reassembly .....	20
Care and Cleaning .....	21
Storage .....	22
Care of Stainless Steel Revolvers .....	23
Fixed Sights .....	23
Service and Parts Policy .....	24
Shipping Firearms For Repair .....	24
Ordering Parts .....	25
Parts List .....	27
Exploded View .....	29
<b>The Basic Rules of Safe Firearms Handling .....</b>	<b>30</b>
Warranty Information .....	36

“RUGER” & “BEARCAT” are registered U.S. trademarks.



**WARNINGS OF GREAT IMPORTANCE ARE  
FOUND ON THE FOLLOWING PAGES:**

Locking Devices	8	Loaded Cylinders	17
Alterations	10	Disassembly	18
Lead Exposure	12	Lubrication	21
Ammunition	12	Storage	22
Handling	13	Shipping	24
Firing	15	Parts Purchasers	25
Safe Carrying Position	17		

**OTHER CAUTIONS AND WARNINGS APPEAR  
THROUGHOUT THE MANUAL.**

# NOMENCLATURE

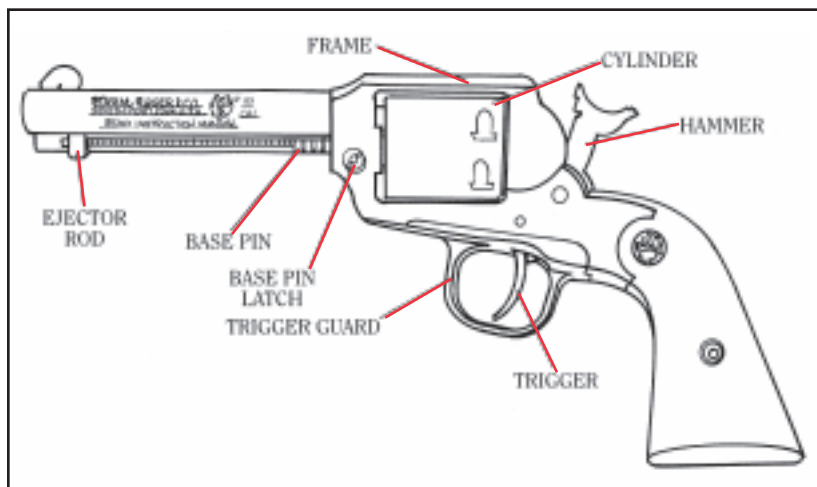

Figure 1a: The hammer is in the Loading Notch position.

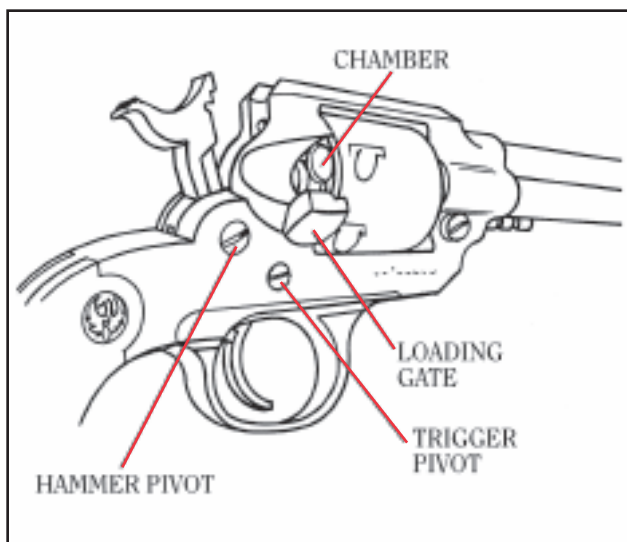

Figure 1b: The loading gate is in the open position (for cartridge loading, unloading, or inspection.)

# LOCKING DEVICE INSTALLATION INSTRUCTIONS



## WARNING – USE OF LOCKING DEVICES



- Always keep your firearm pointed in a safe direction, including when you are installing or removing your locking device.
- Always verify that your firearm is completely **unloaded** before installing your locking device.
- Do not install locking devices in the trigger guard unless the instructions specifically require it; otherwise always keep your fingers and locking device outside the trigger guard during device installation and removal.
- Store firearms, ammunition and keys separately and securely, away from children and careless adults; do not store your firearm with the keys in the locking device.
- Do not attempt to work the action of your firearm with the locking device in place; this may damage your firearm.
- While locking devices are an important aid to security measures, they are not a substitute for safe firearm handling and proper storage. Remember that any mechanical device can be bypassed with enough time, knowledge, determination and equipment.

**LOCKING DEVICES MUST BE USED  
SAFELY AND RESPONSIBLY**

It is important to use the locking device on your Ruger® firearm!

Keep the muzzle pointed in a safe direction and your fingers outside the trigger guard at all times!

### To Install the Factory-Supplied Locking Device:

1. Be sure the firearm and its cylinder are completely unloaded and contain no cartridges or cartridge cases!
2. Press the base pin latch and completely remove the base pin and cylinder.



3. Loop the cable through the cylinder frame and trigger guard (behind the trigger) as shown in Figure 2. **Do not insert the cable directly into the trigger guard in front of the trigger! Only insert the cable as shown in Figure 2.**
4. To lock: With the key turned to the farthest clockwise position, insert the loose end of the cable into the padlock. Turn the key counterclockwise and remove the key.
5. Once the lock is securely closed, pull firmly on the lock to test the connection and be sure it is locked. **Do not leave or store your firearm with the key in the lock!** Store your locked unloaded firearm and the key in secure, separate locations, away from ammunition, children, and unauthorized adults.



**Figure 2**

**Correct Installation of Lock  
For Ruger® New Bearcat® Revolvers Only**

**FIREARMS ARE DANGEROUS WEAPONS  
READ THE INSTRUCTIONS AND WARNINGS IN THIS  
MANUAL THOROUGHLY AND CAREFULLY BEFORE USING.**

 <b>WARNING—ALTERATIONS</b>	
	This product was designed to function properly in its original condition. Alterations can make it unsafe. Do not alter any part or add or substitute parts or accessories not made by Sturm, Ruger & Co., Inc.
	<b>DO NOT ALTER ANY GUN</b>

## GENERAL INFORMATION AND MECHANICAL CHARACTERISTICS

The mechanism of the RUGER® NEW BEARCAT® differs significantly from that of Bearcats® made from 1953-1973 and any other single-action revolvers. The information and instructions which follow apply only to the RUGER® NEW BEARCAT® revolvers with serial numbers above 93-00000.

<p><b>IMPORTANT SAFETY NOTE</b> OWNERS OF ALL “OLD MODEL” (PRE-1973) RUGER SINGLE-ACTION REVOLVERS, INCLUDING BEARCATS WITH SERIAL NUMBERS BELOW 93-00000, SHOULD WRITE FOR DETAILS CONCERNING OUR FREE SAFETY CONVERSION, WHICH CAN HELP PREVENT ACCIDENTS CAUSED BY A BLOW TO THE HAMMER IF THE USER HAS FAILED TO TAKE THE BASIC SAFETY PRECAUTION OF KEEPING AN <u>EMPTY CHAMBER</u> UNDER THE HAMMER. See Page 26.</p>
---

Unlike the earlier single-action revolvers which had four hammer positions – “cocked,” “loading,” “safety” and “all the way forward” – the RUGER® NEW BEARCAT® has only three hammer positions – “cocked,” “loading” and “all the way forward.”

The RUGER® NEW BEARCAT® mechanism incorporates a transfer bar. The transfer bar – which is raised into firing position as the trigger is pulled to the rear – transmits the energy of the hammer blow to the firing pin. This transfer bar mechanism makes a “safety” notch unnecessary.

The only intermediate hammer position between “all the way forward” and “full-cock” is the loading notch. When the hammer is pulled back to this position, the cylinder is unlatched and can be turned for inspection, loading or unloading.

The mechanism of the RUGER® NEW BEARCAT® provides maximum security against accidental discharge. As with any other firearm, however, it must be used with strict attention to correct safety practices. In addition, the revolver should be inspected frequently to assure that it is working properly.

## NEW BEARCAT® MECHANISM

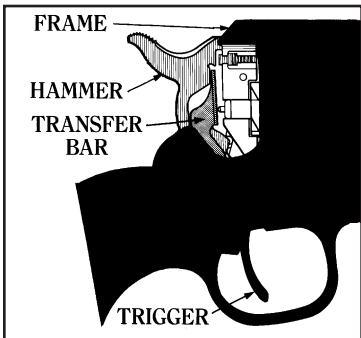

1. Hammer nose on frame. Trigger forward. Transfer bar is below firing pin. This is the "Safe Carrying Position" for Bearcats with serial numbers above 93-00000 only.

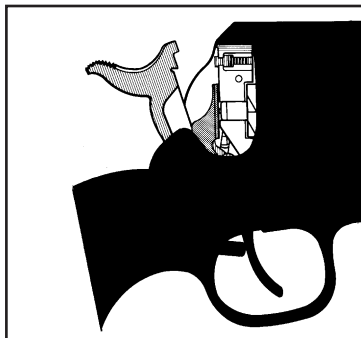

2. Hammer in loading notch position. For loading and unloading only. See "Safe Carrying Position Warning", p. 17.

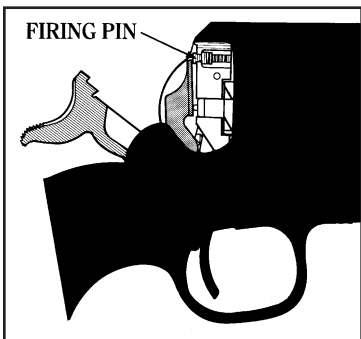

3. Hammer at full-cock. Top of the transfer bar is aligned with firing pin.

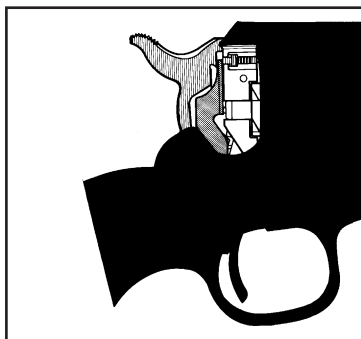

4. With trigger held fully rearward, the hammer actuates firing pin through transfer bar.



## WARNING – LEAD EXPOSURE



Discharging firearms in poorly ventilated areas, cleaning firearms, or handling ammunition may result in exposure to lead and other substances known to the State of California to cause birth defects, reproductive harm, and other serious physical injury. Have adequate ventilation at all times. Wash hands thoroughly after exposure.

**SHOOTING OR CLEANING GUNS  
MAY EXPOSE YOU TO LEAD**

## AMMUNITION

The RUGER® NEW BEARCAT® revolvers are chambered for the 22 Long Rifle Cartridge, 22 Short, 22 Long and 22 CB caps can also be fired in the Long Rifle cylinder. (See “Warning - Ammunition,” below.)



## WARNING – AMMUNITION



Death, serious injury, and damage can result from the wrong ammunition, bore obstructions, powder overloads or incorrect cartridge components. Always wear shooting glasses and hearing protection.

**IMPROPER AMMUNITION  
DESTROYS GUNS**

## **AMMUNITION (CARTRIDGES) NOTICE**

WE SPECIFICALLY DISCLAIM RESPONSIBILITY FOR ANY DAMAGE OR INJURY WHATSOEVER OCCURRING IN CONNECTION WITH, OR AS THE RESULT OF, THE USE IN RUGER® REVOLVERS OF FAULTY, OR NONSTANDARD, OR “REMANUFACTURED” OR HANDLOADED (RELOADED) AMMUNITION, OR OF CARTRIDGES OTHER THAN THOSE FOR WHICH THE FIREARM WAS ORIGINALLY CHAMBERED.

 <h2 style="margin: 0;">WARNING – HANDLING</h2>	
	<p>Any time the revolver is loaded, the hammer is cocked and the trigger is pulled and held to the rear, it will fire. Cocking the gun or pulling the trigger should only be done when you are ready to fire immediately.</p> <p>NEVER DROP OR STRIKE ANY REVOLVER – COCKED OR UNCOCKED – AND CARRY AND HANDLE THE REVOLVER IN SUCH A MANNER THAT THE HAMMER WILL NOT BE STRUCK.</p>
<p><b>NEVER CARRY ANY REVOLVER WITH THE HAMMER COCKED.</b></p>	

## TO LOAD AND FIRE

**ALWAYS KEEP THE REVOLVER POINTED IN A SAFE DIRECTION!**

1. Do not load the revolver until you are ready to use it.
2. Note: The base pin must be fully inserted and locked in position by the base pin latch. If the base pin is not fully inserted and locked, the transfer bar may catch under the firing pin as the hammer is being cocked.
3. With your finger off the trigger, pull the hammer back one “click” so that the trigger snaps forward into the loading notch. This permits the cylinder to rotate.
4. Open the gate.
5. Turn cylinder clockwise, by hand, and insert cartridges into chambers.
6. Align a chamber with the barrel and close the gate. Decock the revolver.

NOTE: The revolver has a cylinder latch that locks the rotation of the cylinder before a shot is fired. This cylinder latch rides on the outside circumference of the cylinder where the stop notches are cut in the cylinder. The cylinder latch is designed to leave a line around the outside of the cylinder between the notches. This is normal and is an indication that your revolver is functioning properly.

## TO ‘UNCOCK’ (DECOCK) THE REVOLVER

To let the hammer down to its forward position (against the frame), proceed as follows: **USE EXTREME CARE WHEN ATTEMPTING TO DECOCK THE REVOLVER, AS THE THUMB SLIPPING DURING THIS PROCESS CAN RESULT IN AN ACCIDENTAL DISCHARGE IF THE TRIGGER IS HELD TO THE REAR.**

1. **Make certain that the revolver is pointing in a safe direction.** (See Rule 2, Page 30.)

2. Make certain both hands are dry and not impeded in any way — gloves, bandages, etc.
3. Grasp the revolver (if right handed) so that the thumb and forefinger of your left hand are firmly holding the frame, forward of the trigger guard. Thus, your left hand is in full control of the revolver (see Figure a, below).
4. Place your right thumb firmly on the hammer spur and, with your thumb securely in control of the hammer, squeeze the trigger only enough to permit the hammer to ‘break free’ of the trigger and carefully lower the hammer past the load notch position. At that instant, **IMMEDIATELY RELEASE THE TRIGGER** and then slowly permit the hammer, **STILL SECURE UNDER YOUR THUMB**, to move fully forward to its resting position against the frame.  
**NOTE:** It is imperative that finger pressure be removed from the **trigger** just as soon as it is past the load notch position of the hammer. Then, properly, the trigger and hammer will move towards their fully forward rest positions together (see Figure b, below).

Practice this important gun handling skill with an unloaded revolver until you have developed the proper control and ‘touch’ to decock your revolver safely. The key to safe decocking is having the weight of the revolver controlled with one hand, while the thumb and forefinger of the ‘shooting hand’ control the hammer and trigger.

## DECOCKING (UNCOCKING) THE REVOLVER

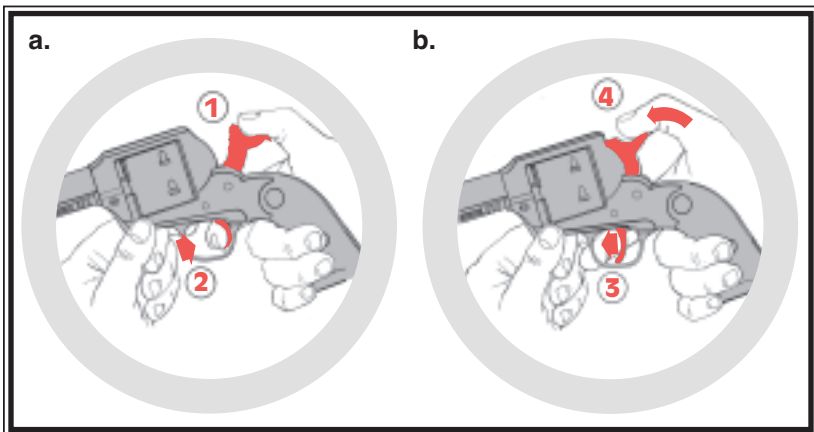

- a. With the thumb controlling the hammer as shown above (1), squeeze trigger to permit hammer to ‘break free’ (2). Carefully lower hammer.
- b. When hammer is past load notch, **IMMEDIATELY** release trigger (3). Then lower hammer slowly to its resting position completely down against frame (4).

The revolver is now in its normal carrying condition — hammer and trigger fully forward and transfer bar lowered out of firing position.



**CAUTION:** The hammer must be carefully eased fully forward before the hammer is drawn back to the full-cock position for the first shot. The hammer should be drawn with a firm positive motion to the full-cock position for each shot, thus actuating the working parts for complete indexing. Unless this procedure is followed in any single-action revolver, the cylinder is apt to be out of index when fired.

5. COCKING – To fire the revolver, the hammer must first be manually cocked. When cocking the hammer, have a firm hold on the grip with the shooting hand, and **DO NOT TOUCH THE TRIGGER WHILE COCKING THE HAMMER. TOUCH THE TRIGGER ONLY WHEN YOU ARE READY TO FIRE.** With the fore portion of your thumb firmly on the hammer spur, draw the hammer fully to the rear until it stops. Then permit the hammer to move forward (it will only be slightly) until the trigger engages in the hammer at full cock.
6. FIRING – Once the hammer has been cocked, a light pressure on the trigger will disengage the trigger from the hammer. The hammer will fall forward striking the transfer bar and the revolver will fire.
7. After firing, the hammer will remain down. To fire subsequent shots, fully release the trigger and repeat steps 7 & 8 above for each shot.



## WARNING – FIRING



When firing any revolver, be sure all persons are a safe distance to the rear of the shooter. When fired, all revolvers discharge gas and particles through the clearance gap between the cylinder and the rear of the barrel. These particles of lead, powder grains or lubricant are projected broadly sideways at high speed and thus can injure a person who is standing too close to the revolver. When firing any revolver, always be certain that nothing – including either of your hands – is in the path of the hot gas and particles which are discharged from the front and sides of the cylinder. When shooting, adequate eye protection is essential. All shooters and bystanders must wear shooting glasses and hearing protection. Exposure to shooting noise can damage hearing.

**HOT GASES EXIT  
BARREL/CYLINDER GAP**

**DRY-FIRING:** Going through the actions of cocking, aiming, and pulling the trigger of an unloaded gun is known as “Dry Firing.” It can be useful to learn the “feel” of your revolver. **Be certain the revolver is unloaded and that the gun is pointing in a safe direction even when practicing by dry-firing.** The RUGER® NEW BEARCAT® revolver can be dry-fired without damage to the firing pin or other components.

**“FANNING”:** NEVER fan the Ruger® Bearcat® revolver. Fanning is an unsafe way to fire a gun and is abusive to the revolver mechanism.

## TO UNLOAD OR EJECT CARTRIDGE CASES

**Keep the revolver pointed in a safe direction! Do not attempt to unload when the hammer is cocked.**

If the hammer is cocked, it must first be decocked. (See instructions pp. 13 - 15.)

Then:

1. Open the gate.
2. **With the finger off the trigger,** pull the hammer back one “click” until the trigger snaps forward into the loading notch. This permits the cylinder to rotate.
3. Turn cylinder clockwise, by hand, to align a chamber with the ejector rod.
4. Push the ejector rod rearwardly, by means of the thumb-piece on its forward end, so that it slides through the chamber to push out the cartridge or fired case. Release spring-loaded ejector rod. Repeat steps 3 and 4 until all chambers are empty.
5. **Check each chamber to be certain that all cartridges have been removed, then close the gate.**

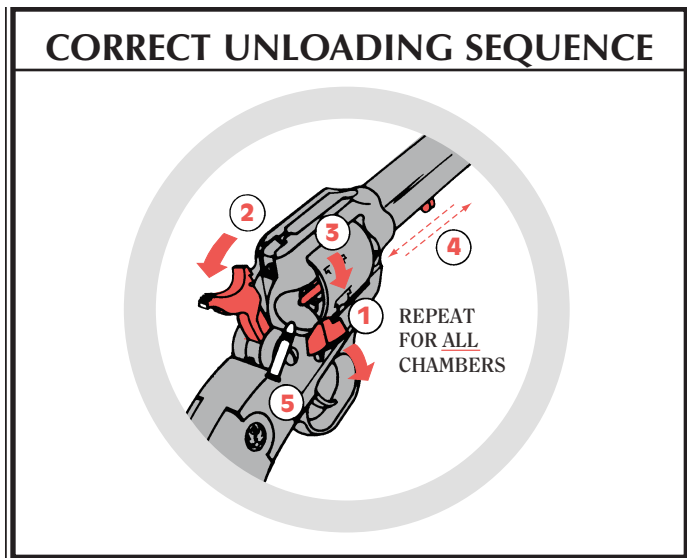

Do not eject unfired cartridges onto any surface where the cartridge rim might strike a solid object and discharge the cartridge.





## WARNING – SAFE CARRYING POSITION



The safe carrying position for a New Bearcat® Revolver is with the hammer fully down and the trigger forward. In this position the hammer does not contact the firing pin. NOTE: In older (1958-1973) Bearcats with serial numbers below 93-00000, the hammer, when in the full forward position, does rest against the firing pin. See Step 1, on page 11.

Accordingly, never carry an “old model” revolver with the hammer fully forward and the cartridge in line with the firing pin because a light blow to the hammer can readily cause discharge. It is always safest to carry the hammer down over an empty chamber regardless of revolvers type. See page 26 for details about our free safety conversion offer for older Bearcats.



*The loading notch must not be used as a carrying safety. Its only purpose is for loading and unloading.* The revolver can be fired by excessive pull on the trigger when the hammer is in the loading notch position. The loading notch provides only partial security against accidental discharge. If this notch is damaged, as it may be by “fanning”, it offers no security. Never depend on this or any mechanical safety device to justify pointing the firearm at yourself or any person.

**ALWAYS CARRY NEW BEARCATS WITH HAMMER DOWN.**

## TO REMOVE OR REPLACE CYLINDER



**WARNING:** Never remove, replace or carry a loaded cylinder. The cartridges can fire if their rims are struck.

1. Open the gate.
2. With the finger off the trigger, pull the hammer back one “click” until the trigger snaps forward into the loading notch. This permits the cylinder to rotate.
3. Press base pin latch (on left side) and withdraw base pin.
4. Remove cylinder from loading gate side of frame.

To replace cylinder, simply reverse the above procedure. Holding the gun with the barrel pointed away from you and in a safe direction, rotate the cylinder 1/4 turn in a clockwise direction to ensure that the pawl is correctly positioned on the cylinder ratchet, before replacing base pin. Finally, close the gate.



## WARNING – DISASSEMBLY

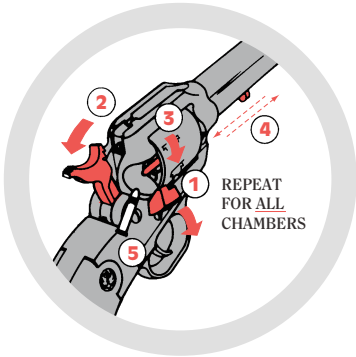

Never clean, lubricate, disassemble or work on a revolver while it is loaded. Never install or remove a loaded cylinder. A loaded cylinder can discharge if dropped or struck. Read instructions before disassembling gun.

**UNLOAD BEFORE CLEANING**

## DISASSEMBLY

The user of a RUGER® NEW BEARCAT® revolver should carefully read all disassembly directions and study all the illustrations and the Parts List in this manual before attempting to take the gun apart. Know the names and location of the parts before removing any of them. Although the RUGER® NEW BEARCAT® revolver mechanism is composed of only a few parts, it is essential that the disassembly and reassembly operations be carried out with knowledge and care.

Only a few tools are required: a screwdriver or two to remove the grip panel and grip frame screws, and a drift punch to remove the hammer and trigger pivots (pins). A small plastic-faced hammer can be useful in drifting the trigger pivot out and in.

The tip of the screwdriver blade should perfectly fit the grip frame screw slots. A tip too large will scrape away metal, while a too-small tip will damage the screw slots.

Before taking the gun apart, set up to do it properly. Cover the work surface with a soft cloth so that the gun finish (and sights) will not be damaged, and provide a tray into which the parts can be put as they are removed from the gun.

## TO DISASSEMBLE FOR CLEANING

**(MAKE SURE REVOLVER IS UNLOADED!)**

An on-line video demonstrating the disassembly and reassembly of the RUGER® BEARCAT® revolvers can be viewed by going to [Ruger.com/TechTips](http://Ruger.com/TechTips).

1. Open the gate, pull the hammer back one “click” into the loading notch and rotate the cylinder a few times to be visually certain the revolver is completely unloaded. Leave the gate open.

2. Press in fully on the left side of the base pin latch, and while holding it in that position, withdraw the base pin. Remove the cylinder and close the gate. This is as far as you need to go for routine cleaning.

## TO DISMANTLE INTERIOR PARTS

1. Remove grip panel screw and lift grip panels away from grip frame.
2. Bring hammer back to full cock position and insert any convenient nail or pin into the small hole at the lower end of the hammer strut; then press the trigger and permit the hammer to move to a forward position. (It will be observed that the pin which has been placed in the hammer strut hole serves to confine the mainspring.)
3. Remove the screw which fastens the trigger guard to the cylinder frame.
4. Remove pawl spring and pawl plunger.
5. Remove the hammer pivot screw, hammer and pawl.
6. With a small screw driver, free the fixed leg of the cylinder latch spring from its anchoring hole on the left inside wall of the cylinder frame.
7. Remove trigger pivot screw, trigger and transfer bar.
8. It will be noted that the trigger spring and plunger are positioned in a hole at the rear of the trigger guard bow. The innermost coil of the trigger spring is enlarged to prevent its loss during disassembly and reassembly, and care should be observed in removing the plunger and spring to prevent deformation of the spring.
9. The hammer plunger is retained in the hammer by means of a small pin which may be removed by means of a small drift.

*NOTE: Always use a good quality screw driver which properly fits the screw slots to avoid unsightly deformation of the screw heads.*

ALTHOUGH THE FOREGOING OUTLINES THE CORRECT PROCEDURE, WE WISH TO EMPHASIZE THAT SUCH DETAILED DISMANTLING IS SELDOM IF EVER NECESSARY.

The revolver is, at this stage, disassembled as far as it needs to be for major cleaning and maintenance. However, if it is necessary to go beyond the above steps, the following cautions and suggestions should be carefully followed:

**Ejector/Ejector Housing:** Wrap one hand firmly around barrel and housing when loosening the screw. Remove screw, then carefully lift housing (which contains compressed spring and ejector rod) away from the barrel.

**Base Pin Latch/Nut and Spring:** The nut must be held firmly (with jaw-protected pliers) while the latch is being unscrewed. Don't lose the spring. When reassembling, be certain the nut and spring are on the left side of the frame. (See Exploded View drawing, p. 29.)

# REASSEMBLY

(AGAIN, MAKE SURE REVOLVER IS UNLOADED!)

1. Assemble pawl to hammer and transfer bar to trigger. Partially insert hammer/pawl assembly in its recess in the frame. Insert trigger/transfer bar assembly in its slot in the frame. Then complete insertion of the two assemblies into the frame.
2. Align hammer in frame and insert hammer pivot screw.
3. Install pawl spring and pawl plunger.
4. Replace cylinder latch and spring. Then, install trigger pivot screw.
5. Insert the base pin, taking care to be certain the 'dished out' section of the base pin collar is adjacent to the bottom of the barrel. The base pin must be fully inserted and locked in position by the base pin latch. If the base pin is not fully inserted and locked, the transfer bar may catch under the firing pin when the hammer is being cocked.
6. Install mainspring assembly in the grip frame. Be certain the strut is positioned properly. See the Parts Drawing for correct strut positioning.
7. Be certain the mainspring strut seat is correctly positioned on its step in the grip frame. Then, draw the hammer back to the full cock position and remove the small pin from the mainspring strut. Pull trigger and allow hammer to fall. Pull the hammer back one "click" to the loading notch.
8. Open the gate, withdraw base pin and install the cylinder. Reinsert the base pin and be certain it is fully seated and locked in position.
9. Before loading cartridges into the chamber, cycle the revolver several times. Check to be sure that cylinder rotates and locks correctly; that trigger returns in a positive manner when released; and that loading gate opens and closes normally.

## CARE AND CLEANING



**Always be certain the revolver is completely unloaded before cleaning.** At regular intervals, or when the revolver has been exposed to sand, water or other adverse conditions, disassemble, clean and oil it.

To clean the revolver after firing:

1. Remove the cylinder as described on p. 17.
2. Clean the barrel from the muzzle by running a cleaning rod with solvent coated patch through the bore several times. A bronze wire brush, of a size appropriate to the bore, attached to the cleaning rod should then be pushed the full length of the bore several times.
3. Again swab the bore with a solvent coated patch. Then wipe the rod clean and, using a dry patch, swab the bore until it is clean.
4. Repeat the above procedure for each of the six chambers.
5. Run a lightly oiled patch through the bore and each chamber.

Some cartridges with lead bullets deposit metal fouling in the chamber throats, in the forcing cone of the barrel and in the bore. If 'leading' is noted in your revolver, clean it out before it builds up and interferes with reliable functioning and accuracy. A special 'lead removing' cleaning tool (for bore and chambers) is available from gun stores.

The revolver's internal mechanism can be lubricated without disassembly. A few drops of light oil recommended as suitable for firearms, applied periodically about the various frame openings, will work its way into the mechanism parts. The exterior of the revolver should be cleaned with a solvent and then wiped with an oily cloth.

 <b>WARNING – LUBRICATION</b>	
	<p>Firing a revolver with oil, grease, or any other material even partially obstructing the bore may result in damage to the revolver and serious injury to the shooter and those nearby.</p> <p>Do not spray or apply lubricants directly on ammunition. If the powder charge of a cartridge is affected by the lubricant, it may not be ignited, but the energy from the primer may be sufficient to push the bullet into the bore where it may become lodged. Firing a subsequent bullet onto the obstructed bore may damage the revolver and cause serious injury or death to the shooter and those nearby. Use lubricants properly. You are responsible for the proper care and maintenance of your firearms.</p>
<b>IMPROPER LUBRICATION DESTROYS GUNS</b>	

# STORAGE

GUNS SHOULD NOT BE STORED LOADED!

**USE THE LOCKING DEVICE SUPPLIED WITH THE REVOLVER TO RENDER IT INOPERATIVE FOR SAFE STORAGE.**

(SEE PAGE 8)

*Do not* keep your revolver in a leather, fabric or canvas holster when it is stored. These materials attract moisture, even though the holster may appear to be perfectly dry.

 <b>WARNING – STORAGE</b>	
	<ul style="list-style-type: none"><li>• Never place or store any firearm in such a manner that it may be dislodged. Firearms should always be stored securely and unloaded, away from children and careless adults.</li><li>• Use the locking device supplied with the revolver for storage. The use of a locking device or safety lock is only one aspect of responsible firearms storage.</li><li>• For increased safety, firearms should be stored unloaded in a location that is both separate from their ammunition and inaccessible to children and any other unauthorized person.</li></ul>
<b>STORE SECURELY &amp; UNLOADED</b>	

## CARE OF STAINLESS STEEL REVOLVERS

Revolvers made of stainless steel are more resistant to corrosion than blued steel revolvers. However, in the interest of proper operation and long life of your revolver, inspect it frequently and clean, lubricate and apply an appropriate rust preventative.

Sometimes surface discoloration may be noted, particularly in the grip area of stainless steel revolvers, resulting from perspiration. Contact with some types of holsters can also cause stains or rusting. Rusting may also occur as a result of the revolver being exposed to moisture, humidity, salt air or chemicals.

Minor discoloration can usually be removed by rubbing the stained area with an abrasive ink eraser, crocus cloth, or a "metal polishing" compound. When using any of these abrasives, proceed with care and use light pressure to achieve a blending of 'color' with those areas that are not discolored.

External surfaces of the barrel, frame and cylinder should be cleaned and wiped dry after use or after exposure to adverse conditions. If the revolver is to be stored, coat it with a light film of oil or preservative. Where the revolver is in continuing use, and the presence of oil or grease would be objectionable, then the external surface can be coated (after cleaning and drying) with a paste wax formulated for use on metals. Apply the wax sparingly, allow time for it to dry hard, then buff lightly with a soft cloth. When applying the wax, take care that it does not get into the mechanism or on the functioning parts such as the hammer, trigger, crane latch, etc. A properly applied hard wax coating will not interfere with gun handling, and it will provide a measure of protection.

## FIXED SIGHTS

RUGER® NEW BEARCAT® revolvers feature a blade front sight and fixed rear sight. They are factory set to be on target at 25 yards and cannot be further adjusted.

## SERVICE AND PARTS POLICY

If you have any questions with regard to the performance of your RUGER® NEW BEARCAT® revolver, please write or call (336-949-5200) our Customer Service Department, 411 Sunapee Street, Newport, New Hampshire 03773, fully describing all circumstances and conditions involved. If you should return your revolver to the factory for repair, or order parts for it, please comply with the following suggestions for prompt service:



**WARNING: BEFORE SHIPPING ANY FIREARM, BE ABSOLUTELY CERTAIN THAT IT AND ITS CYLINDERS ARE UNLOADED. DO NOT SHIP CARTRIDGES WITH A FIREARM.**

### SHIPPING FIREARMS FOR REPAIR

RUGER® NEW BEARCAT® revolvers returned to the factory for repair should be sent to: Sturm, Ruger & Company, Inc., Customer Service Department, 411 Sunapee Street, Newport, New Hampshire 03773. The complete revolver should be shipped. **NOTE: You must obtain a Repair Authorization Number before returning your firearm.** An authorization number can be obtained by contacting Customer Service online at [www.ruger.com](http://www.ruger.com) or calling the Customer Service Dept. at 336-949-5200. Guns should be sent prepaid. We will not accept collect shipments.

The Federal Gun Control Act, as well as the laws of most states and localities, do not prohibit an individual (who is not otherwise barred from purchasing or possessing a firearm) from shipping a firearm directly to the manufacturer for repair. However, before you ship your firearm to us, be certain that your state or locality does not have a law or regulation which will prohibit you from receiving it from us after it has been repaired. If such receiving is prohibited, then please have a federally licensed firearms dealer ship the gun to us. If it is sent to us by a dealer, it will be returned to that dealer after being repaired. If a handgun (pistol or revolver) is shipped by an individual who does not hold a Federal Firearms License, it must be shipped for overnight delivery via U.P.S., Federal Express, or other similar private overnight service. **NOTE:** Handguns may not be shipped via U.S. Mail. Persons who do not hold a Federal Firearms License are prohibited by Federal law from shipping a handgun by mail. Handguns mailed in violation of the law are impounded by the Post Office. Rifles and shotguns may be shipped via U.S. Mail. Always insure your shipment.

**DO NOT SEND GUN BOXES OR LITERATURE THAT YOU CONSIDER TO BE COLLECTOR'S ITEMS – THESE ARE INVARIABLY DAMAGED OR DESTROYED IN SHIPMENT.** Please do not include holster, grips, or other accessories with a firearm being shipped to the factory for service. Always insure your shipment.

Enclose a letter which includes your name, address, telephone number, serial number, model of the firearm, and your repair authorization number. Describe in detail the trouble you have experienced with your firearm, or the work you wish to have done. Merely stating that the firearm "needs repair" is inadequate information. Please enclose copies of any previous correspondence.



All work performed is subject to a minimum labor charge and charges for shipping and handling. Most models can be reblued, but custom gunsmithing service or nonstandard alterations are NOT AVAILABLE from Ruger Customer Service Departments. Please contact the Customer Service Department for pricing information.

 <b>WARNING – PARTS PURCHASERS</b>	
	<ul style="list-style-type: none"><li>• It is the purchaser's responsibility to be absolutely certain that any parts ordered from the factory are correctly fitted and installed.</li><li>• Firearms are complicated mechanisms and <b>IMPROPER FITTING OF PARTS MAY RESULT IN A DANGEROUS MALFUNCTION, DAMAGE TO THE FIREARM, AND SERIOUS INJURY TO THE SHOOTER AND OTHER PERSONS.</b></li><li>• The purchaser and installer of parts must accept full responsibility for the correct adjustment and functioning of the firearm after such installation.</li></ul>
<b>PARTS MUST FIT CORRECTLY</b>	

## ORDERING PARTS

Please contact the New Hampshire Customer Service Department for parts availability and current prices. All parts orders for the RUGER® NEW BEARCAT® should be sent to: Sturm, Ruger & Company, Inc., Customer Service Department, 411 Sunapee Street, Newport, New Hampshire 03773, 336-949-5200.

We cannot comply with open account or C.O.D. requests. Payment in full via credit card (Visa or MasterCard only), money order or certified bank check (no personal checks or cash, please) is required before any service will be performed. Please provide your credit card number, your name as it appears on the credit card, the expiration date, and 3-digit security code. All parts orders are subject to a minimum charge and charges for shipping and handling. Order parts by **Part Name and specify the model and entire serial number** of the firearm for which the parts are being ordered. There is a minimum labor charge plus a shipping and handling charge if the parts are factory fitted. All factory fitted parts are fit on an exchange basis only. We will not return the replaced parts. Please contact the Customer Service Department for pricing information.

\*Parts designated by an asterisk must be factory fitted. These parts are fitted on an exchange basis only. We will not return the replaced parts. We will not return any part that is broken, malfunctioning, badly worn or has been modified. See "Warning – Parts Purchasers," above.

Because it is a serial-numbered component, the frame of RUGER® NEW BEARCAT® revolvers is defined as a “firearm” by Federal Law and is not offered for sale separately.

IMPORTANT – REGARDING PARTS ORDERING. Ruger® New Model Single-Action revolvers are manufactured in Blued steel and Stainless steel versions. WHEN ORDERING PARTS BE SURE TO STATE WHETHER YOUR REVOLVER IS BLUED OR STAINLESS. ALSO, INCLUDE THE COMPLETE SERIAL NUMBER AND SPECIFY THE CALIBER AND BARREL LENGTH.

NOTE: A few components, as example grip panels, are the same for blued and stainless models

BARREL NOTE: All barrels are marked with a safety message, “Before using gun, read warnings in Instruction Manual available free from Sturm, Ruger & Co., Inc., Southport, CT, USA.”



**WARNING:** A gun containing broken, malfunctioning, or badly worn parts should not be fired!

## SHIPPING REVOLVERS FOR INSTALLATION OF A SAFETY CONVERSION KIT:

If you would like to have any “old model” (pre-1973) Bearcat®, Single-Six®, Blackhawk®, or Super Blackhawk® revolver factory fitted with a free Conversion Kit (to help prevent accidents caused by a blow to the hammer if the user has failed to keep an empty chamber under the hammer) please write to Ruger, Conversion Dept., 411 Sunapee Street, Newport, NH 03773 for a box and shipping instructions. Be sure to include information as to model, caliber, and serial number. Please do not send your old model single-action revolver until you receive shipping instructions and a box from us. Please note that the Kit will be fitted at our Newport, New Hampshire facility. All other servicing of “old model” single actions will also be performed at our Newport facility, but only after a Conversion Kit is first installed.

This safety conversion does not apply if the revolver is marked “Vaquero,” “New Vaquero,” “Bisley™,” or “New Bearcat” on the frame.

# RUGER® NEW BEARCAT®

## PARTS LIST

Design, prices and specifications subject to change without notice.

**SPECIFY MODEL, CALIBER AND SERIAL NO. WHEN ORDERING**

(See Exploded View Page 29)

<b>Key No.</b>	<b>Part Name</b>
* 1	Barrel
*† 2	Base Pin Assembly
3	Base Pin Latch Body
4	Base Pin Latch Nut
5	Base Pin Latch Spring
* 6	Cylinder
*† 7	Cylinder Latch Assembly
*† 8	Cylinder Latch Spring
9	Cylinder Latch Spring Plunger
10	Ejector Housing
11	Ejector Housing Screw
12	Ejector Rod Assembly
13	Ejector Rod Spring
14	Firing Pin
15	Firing Pin Rebound Spring
16	Front Sight
17	Gate
18	Gate Plunger
19	Gate Plunger Spring
20	Gate Spring Retaining Screw
21	Grip Panels, Complete with Screw
22	Grip Panel Dowel
23	Grip Panel Medallion, 2 Req'd
24	Grip Panel Screw
*† 25	Hammer
26	Hammer Pivot Pin
27	Hammer Strut
28	Mainspring
29	Mainspring Seat
*† 30	Pawl

\* PARTS SO MARKED MUST BE FACTORY FIT.

† These parts are also available as a free factory safety retrofit for all older Bearcats manufactured between 1958 - 1973 with serial numbers below 93-00000, see p. 26.

<b>Key No.</b>	<b>Part Name</b>
31	Pawl Plunger
32	Pawl Plunger Spring
33	Pawl Spring Retaining Screw
34	Recoil Plate
35	Recoil Plate Cross Pin
*† 36	Transfer Bar
*† 37	Trigger
38	Trigger Guard
39	Trigger Guard Screw-A-Front
40	Trigger Pivot Screw
*† 41	Trigger Spring
42	Trigger Spring Plunger
** 43	Frame

\* PARTS SO MARKED MUST BE FACTORY FIT.

† These parts are also available as a free factory safety retrofit for all older Bearcats manufactured between 1958 - 1973 with serial numbers below 93-00000, see p. 25.

\*\* The frame is a serial-numbered part and is not offered for sale.

# RUGER® NEW BEARCAT® EXPLODED VIEW

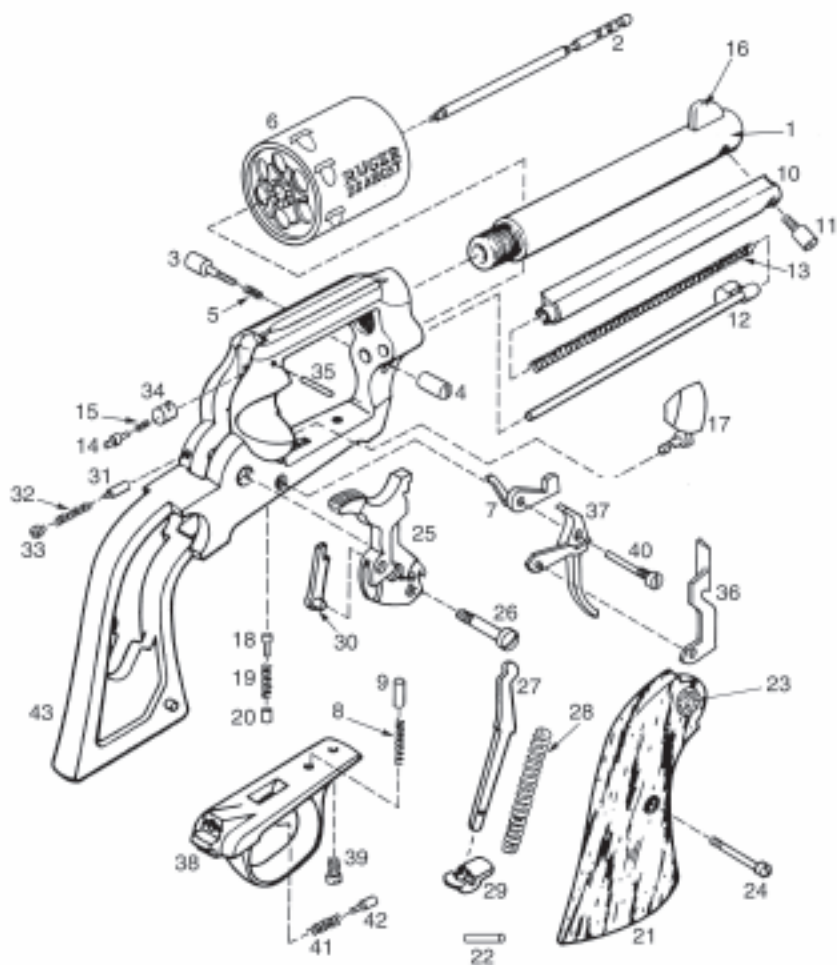

# THE BASIC RULES OF SAFE FIREARMS HANDLING

We believe that Americans have a right to purchase and use firearms for lawful purposes. The private ownership of firearms in America is traditional, but that ownership imposes the responsibility on the gun owner to use his firearms in a way which will ensure his own safety and that of others. When firearms are used in a safe and responsible manner, they are a great source of pleasure and satisfaction, and represent a fundamental part of our personal liberty.

Firearms do not cause accidents! Firearms accidents are almost always found to have been the result of carelessness or ignorance on the part of the shooter of the basic rules of safe gun handling.

The following rules must be observed by gun users at all times. Safe gun handling is not just desirable, it is absolutely essential to your safety, the safety of others, and the continuation of gun ownership and sport shooting as we know it today.

## 1. LEARN THE MECHANICAL AND HANDLING CHARACTERISTICS OF THE FIREARM YOU ARE USING.



Not all firearms are the same. The method of carrying and handling firearms varies in accordance with the mechanical provisions for avoiding accidental discharge and the various proper procedures for loading and unloading. No person should handle any firearm without first having thoroughly familiarized himself with the particular type of firearm he is using, and with safe gun handling in general.

## 2. ALWAYS KEEP THE MUZZLE POINTED IN A SAFE DIRECTION.



Be sure of the bullet stop behind your target, even when dry-firing. Never let the muzzle of a firearm point at any part of your body or at another person. This is particularly important when loading or unloading a firearm. In the event of an accidental discharge, no injury can occur as long as the muzzle is pointing in a safe direction. A safe direction means a direction that will not permit a discharged bullet to strike a person, or to strike an object from which the bullet may ricochet.

A safe direction must take into account the fact that a bullet may penetrate a wall, ceiling, floor, window, etc., and strike a person or damage property. Make it a habit to know exactly where the muzzle of your gun is pointing whenever you handle it, and be sure that you are always in control of the direction in which the muzzle is pointing, even if you fall or stumble. Keep your finger off the trigger until you are ready to shoot.

### 3. FIREARMS SHOULD BE UNLOADED WHEN NOT IN USE.

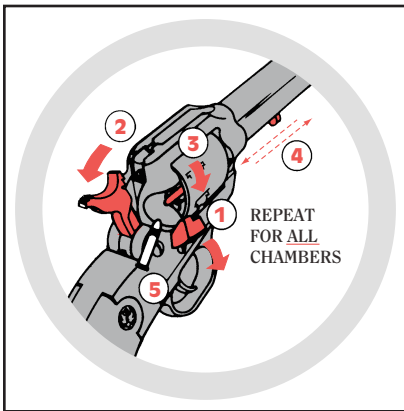

Firearms should be loaded only when you are in the field or on the target range or shooting area, ready to shoot. Firearms and ammunition should be securely locked in safes, racks or cabinets, or by using the locking device supplied with the firearm, when not in use. Ammunition should be safely stored separate from firearms. Store your firearms out of sight of visitors and children. It is the gun owner's responsibility to be certain that children and

persons unfamiliar with firearms cannot gain access to firearms, ammunition, or components.

### 4. BE SURE THE BARREL IS CLEAR OF OBSTRUCTIONS BEFORE SHOOTING.

Even a bit of mud, snow or excess lubricating oil or grease in the bore may cause the barrel to bulge, or even burst on firing, and can cause serious injury to the shooter and bystanders. Be sure that you are using ammunition of the proper caliber and loading for the gun you are using. If the report or recoil on firing seems weak, or doesn't seem quite right, CEASE FIRING IMMEDIATELY, unload your firearm, and check to be sure that no obstruction has become lodged in the barrel.





### 5. BE SURE OF YOUR TARGET BEFORE YOU SHOOT.

Don't shoot unless you know exactly where your bullet is going to strike. Be sure of the bullet stop behind your target, even when dry-firing with an unloaded gun. If you are in the field hunting, do not fire at a movement or noise. Take the time to be absolutely certain of your target before you pull the trigger.

### 6. WEAR SHOOTING GLASSES AND HEARING PROTECTION WHEN YOU SHOOT.

All shooters should wear protective shooting glasses and adequate hearing protection when shooting. Exposure to shooting noise can damage hearing, and wearing adequate eye protection when shooting is essential.



### 7. NEVER CLIMB A TREE OR FENCE WITH A LOADED FIREARM.

Put the firearm down carefully before climbing a fence, and unload it before climbing or descending a tree or jumping over a ditch or other obstruction. Never pull or push a loaded firearm toward yourself or another person. When in doubt, or whenever you are about to do anything awkward, unload your gun!



**8. DON'T SHOOT AT A HARD SURFACE OR AT WATER.**

Bullets can glance off many surfaces like rocks or the surface of water and travel in unpredictable directions with considerable velocity.



**9. NEVER TRANSPORT A LOADED FIREARM.**

Firearms should always be unloaded before being placed in a vehicle. A suitable carrying case or scabbard should be used to carry an unloaded firearm to and from the shooting area.

**10. AVOID ALCOHOLIC BEVERAGES WHEN SHOOTING.**

Don't drink until the day's shooting is over. Handling firearms while under the influence of alcohol in any form, or medications that could affect your judgment or coordination, constitutes a criminal disregard for the safety of others.



## A BRIEF ACCOUNT OF AN EXTRAORDINARY ACHIEVEMENT: RUGER® FIREARMS

Sturm, Ruger & Company, Inc., had its beginning in a small machine shop occupying a rented frame building in Southport, Connecticut. In January, 1949, with an initial investment of only \$50,000 and an idea, William B. Ruger and Alexander M. Sturm started production of a .22 caliber autoloading pistol—a design which was so successful that it became the cornerstone upon which one of the most comprehensive lines of sporting firearms ever made in America was established. After Alex Sturm's death in 1951, William B. Ruger continued to direct the Company until his death in 2002. William B. Ruger, Jr. continued to provide guidance, which helped make this Company a sound and successful enterprise, until his retirement in 2006. The Company has continued to prosper, under new management and guidance from our Board, with new products and fresh perspectives.

Ruger, in this relatively short time, has established itself as a leading small arms design organization, developing a unique and broad line of fine quality sporting, military and police firearms to become one of the world's most famous producers of revolvers, pistols, rifles and shotguns. Since 1949, Ruger craftsmen have built many millions of firearms.

During its five decades of growth and progress under the leadership of William B. Ruger, the Company developed a business philosophy and implemented policies which represent a constructive influence in the life of modern America. From the beginning, Ruger played a positive role in conservation efforts and has supported the interests of shooters through such groups as the National Rifle Association, National Shooting Sports Foundation, and many regional sportsmen's organizations.

The Company has always endeavored to market its firearms for constructive and recreational purposes, to emphasize the traditional and responsible aspects of shooting, to render meaningful public services, and to encourage shooters in constructive, responsible, and safe participation in the shooting sports. Its motto, "Arms Makers For Responsible Citizens®," exemplifies this Company philosophy.

Today, Ruger® is particularly mindful of those elements which have contributed to the creation of its success, and extends heartfelt thanks to its many loyal employees and customers.

The firearms catalog, and instruction manuals for all Ruger® firearms, can be downloaded from our website at:

**[www.ruger.com](http://www.ruger.com)**

# NOTES

## WHY NO WARRANTY CARD HAS BEEN PACKED WITH THIS NEW RUGER® FIREARM

The Magnuson-Moss Act (Public Law 93-637) does not require any seller or manufacturer of a consumer product to give a written warranty. It does provide that if a written warranty is given, it must be designated as "limited" or as "full" and sets minimum standards for a "full" warranty. Sturm, Ruger & Company, Inc. has elected not to provide any written warranty, either "limited" or "full", rather than to attempt to comply with the provisions of the Magnuson-Moss Act and the regulations issued thereunder. There are certain implied warranties under state law with respect to sales of consumer goods. As the extent and interpretation of these implied warranties varies from state to state, you should refer to your state statutes. Sturm, Ruger & Company wishes to assure its customers of its continued interest in providing service to owners of Ruger® firearms.



**STURM, RUGER & COMPANY, INC.**  
411 SUNAPEE STREET  
NEWPORT, NEW HAMPSHIRE 03773 U.S.A.  
[WWW.RUGER.COM](http://WWW.RUGER.COM)

**ARMS MAKERS FOR RESPONSIBLE CITIZENS®**

**A COPY OF THE INSTRUCTION MANUAL FOR ANY RUGER®  
FIREARM IS AVAILABLE FROM THE FACTORY FREE ON REQUEST, OR IT MAY BE  
DOWNLOADED FROM OUR WEBSITE AT [WWW.RUGER.COM](http://WWW.RUGER.COM).  
THESE INSTRUCTION MANUALS CONTAIN IMPORTANT  
WARNINGS WHICH MUST BE UNDERSTOOD  
BEFORE USING THESE FIREARMS.**

**The Following are Sturm, Ruger & Co., Inc. Trademarks:** "BX-Trigger," "Bisley," Eagle Hard "R" logo holding gun, "Elite 452," "Gold Label," "I'm a Ruger American," "LC6," "LCR-357," "LC380CA," "Mark II," "Mark III," "Match Champion," "Model 96," "P345," "P345D," "P345PR," "P85," "P90," "P91," "P93," "P94," "P95," "P97," "R.I.O.S.," "Ruger Marksman Adjustable," "Ruger 77/50," "Ruger 10/17," "Ruger Titanium," "77/357," "Single-Seven," "SR45," "SR-556C," "SR-556VT," "SR-762," "10/22-FS," "This is Ruger. This is America.," "Tri-Flex," "22 Charger," "22/45," and "22/45 RP."

**The Following are Registered U.S. Trademarks Belonging to Sturm, Ruger & Co., Inc.:** Sturm, Ruger Logo, "AC-556," "AR-556," "Arms Makers For Responsible Citizens," "All-Weather," "Bearcat," "Blackhawk," "BX-15," "BX-25," Eagle 'R' - soft 'R' & hard 'R', Eagle 'SR', "Everything you need and nothing you don't.," "GP100," "Hawkeye," "It's Mine and It's American," "It's Mine. And It's American," "LC380," "LC9," "LC9s," "LC9s Pro," "LCP," "LCR," "LCRx," "M77," "Mini Thirty," "Mini-14," "9E," "Old Army," "Power Bedding," "Redhawk," "RUGER," "Ruger American Pistol," "Ruger American Rifle," "Ruger American Rimfire," "Ruger Hunting" - phrase & logo design, "Ruger Inside & Out" - phrase & logo design, "Ruger Precision Rifle," "Ruger 77/17," "Ruger 77/22," "Ruger 77/44," "Ruger SP101," "Ruger 10/22 Takedown" phrase & logo design, "Ruger 22/45 Lite," "Ruger Vaquero," "Rugged, Reliable Firearms," "Security-Six," "Service-Six," "Silent-SR," "Single-Nine," "Single-Six," "Single-Ten," "Speed-Six," the "SR" Design, "SR9," "SR9c," "SR40," "SR40c," "SR-22," "SR22," "SR-556," "SR-556E," "SR-556 Takedown," "SR1911," "Super Redhawk Alaskan," "Target Grey," and "10/22."